

Description: 824-2170MHz SMD Antenna

Series: Domino

PART NUMBER: W3544X



### Features:

- Frequency
  - 824-960/1710-2170MHz
- Impedance 50 Ohm
- Efficiency average
  - 40%/55% for W3544A
  - 55%/57% for W3544B
- Size 7.65 x 26 x 3 mm
- SMD Compliant
- A and B variants for different mounting positions on PCB

### Applications:

- 2G/3G Cellular antenna
- GPRS
- Nb-IoT, LTE Cat M1

All dimensions are in mm

Issue: 2045

In the effort to improve our products, we reserve the right to make changes judged to be necessary.

CONFIDENTIAL AND PROPRIETARY INFORMATION

This document contains confidential and proprietary information of Pulse Electronics, Inc. (Pulse) and is protected by copyright, trade secret and other state and federal laws. Its receipt or possession does not convey any rights to reproduce, disclose its contents, or to manufacture, use or sell anything it may describe. Reproduction, disclosure or use without specific written authorization of Pulse is strictly forbidden.

For more information:

Pulse Worldwide Headquarters  
15255 Innovation Drive #100  
San Diego, CA 92128  
USA  
Tel: 1-858-674-8100

Pulse/Larsen Antennas  
18110 SE 34<sup>th</sup> St Bldg 2 Suite 250  
Vancouver, WA 98683  
USA  
Tel: 1-360-944-7551

Europe Headquarters  
Pulse GmbH & Do, KG  
Zeppelinstrasse 15  
Herrenberg, Germany  
Tel: 49 7032 7806 0

Pulse (Suzhou) Wireless Products Co, Inc.  
99 Huo Ju Road(#29 Bldg,4<sup>th</sup> Phase  
Suzhou New District  
Jiangsu Province, Suzhou 215009 PR China  
Tel: 86 512 6807 9998



Description: 824-2170MHz SMD Antenna

Series: Domino

PART NUMBER: W3544X

### ELECTRICAL SPECIFICATIONS\*

Frequency	824-960/1710-2170MHz
Nominal Impedance	50Ω
Return Loss	<-3dB/-4dB for W3544A <-4dB/-4dB for W3544B
Average Radiation Efficiency	40%/55% for W3544A 55%/57% for W3544B
Average Peak Gain	-0.9dBi/1.5dBi for W3544A 1.9dBi/1dBi for W3544B
Maximum power input	3W

### MECHANICAL SPECIFICATIONS

Overall Length	7.65 x 26 x 3 mm
Weight	1.11 g
Antenna Color	Black
Mounting	SMD
Moisture Sensitivity Level	MSL3

### ENVIRONMENTAL SPECIFICATIONS

Operating Temperature	-45 ~ 85° C
Storage Temperature	-45 ~ 85° C
RoHS Compliant	Yes

(\*) All RF parameters measured on Pulse reference test PCB

Issue: 2045

In the effort to improve our products, we reserve the right to make changes judged to be necessary.

CONFIDENTIAL AND PROPRIETARY INFORMATION

This document contains confidential and proprietary information of Pulse Electronics, Inc. (Pulse) and is protected by copyright, trade secret and other state and federal laws. Its receipt or possession does not convey any rights to reproduce, disclose its contents, or to manufacture, use or sell anything it may describe. Reproduction, disclosure or use without specific written authorization of Pulse is strictly forbidden.

Description: 824-2170MHz SMD Antenna

Series: Domino

PART NUMBER: W3544X

MECHANICAL DRAWING

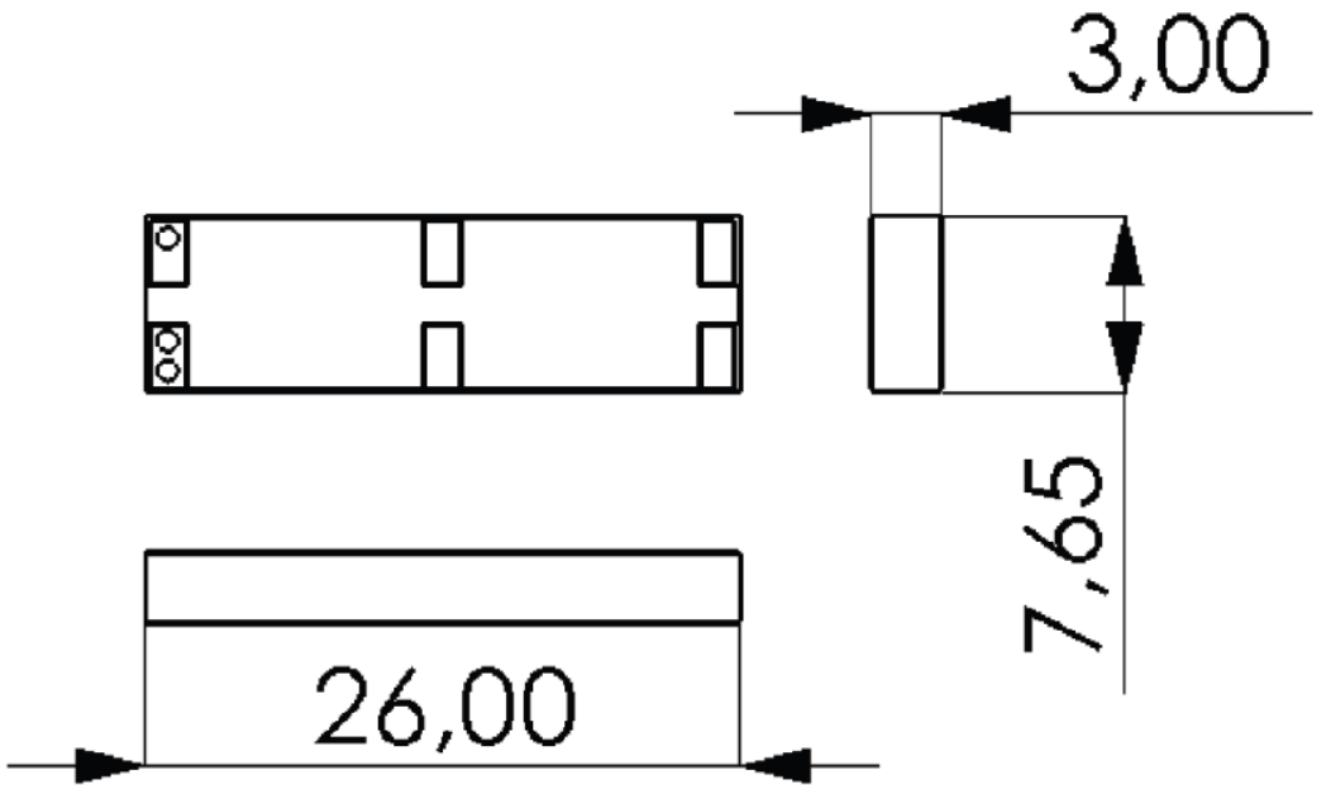

Issue: 2045

In the effort to improve our products, we reserve the right to make changes judged to be necessary.

CONFIDENTIAL AND PROPRIETARY INFORMATION

This document contains confidential and proprietary information of Pulse Electronics, Inc. (Pulse) and is protected by copyright, trade secret and other state and federal laws. Its receipt or possession does not convey any rights to reproduce, disclose its contents, or to manufacture, use or sell anything it may describe. Reproduction, disclosure or use without specific written authorization of Pulse is strictly forbidden.

## Recommendation for reflow soldering process

Printing stencil thickness 0,15 - 0,25 mm is recommended for the solder paste. The maximum soldering temperature should not exceed 260°C. The temperature profile recommendations for reflow soldering process is presented in the Figures 1 and 2. The reflow profile

presented in figure 1 describes minimum reflow temperatures. The reflow profile presented in figure 2 describes maximum reflow temperatures. located at the center of the coverage area.

	Method of heat transfer	Controlled hot air convection
1	Average temperature gradient in preheating	2.5 °C/s
2	Soak time	2-3 minutes
3	Max temperature gradient in reflow	3 °C/s
4	Time above 217 °C	Max 30 sec
5	Peak temperature in reflow	230 °C for 10 seconds
6	Temperature gradient in cooling	Max -5 °C/s

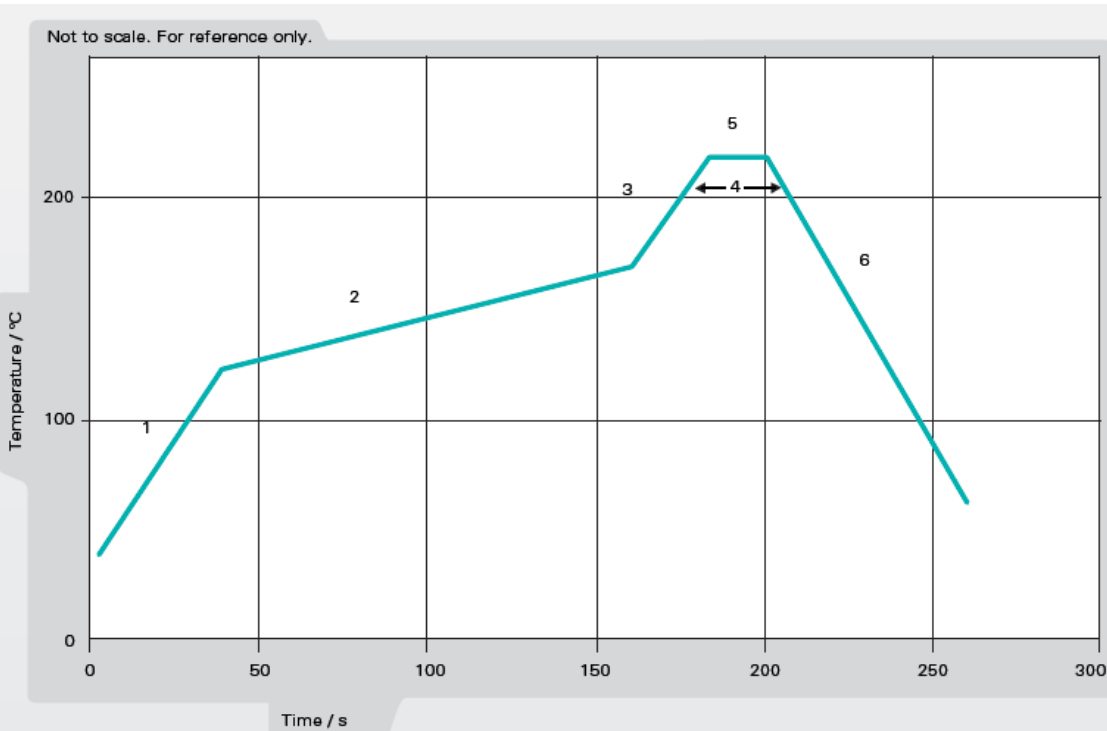

Figure 1. Minimum temperature profile recommendation for reflow soldering process

Description: 824-2170MHz SMD Antenna

Series: Domino

PART NUMBER: W3544X

## Recommendation for reflow soldering process

	Method of heat transfer	Controlled hot air convection
1	Average temperature gradient in preheating	2.5 °C/s
2	Soak time	2-3 minutes
3	Max temperature gradient in reflow	3 °C/s
4	Time above 217 °C	Max 60 sec
5	Time above 230 °C	Max 50 sec
6	Time above 250 °C	Max 10 sec
7	Peak temperature in reflow	260 °C for 5 seconds
8	Temperature gradient in cooling	Max -5 °C/s

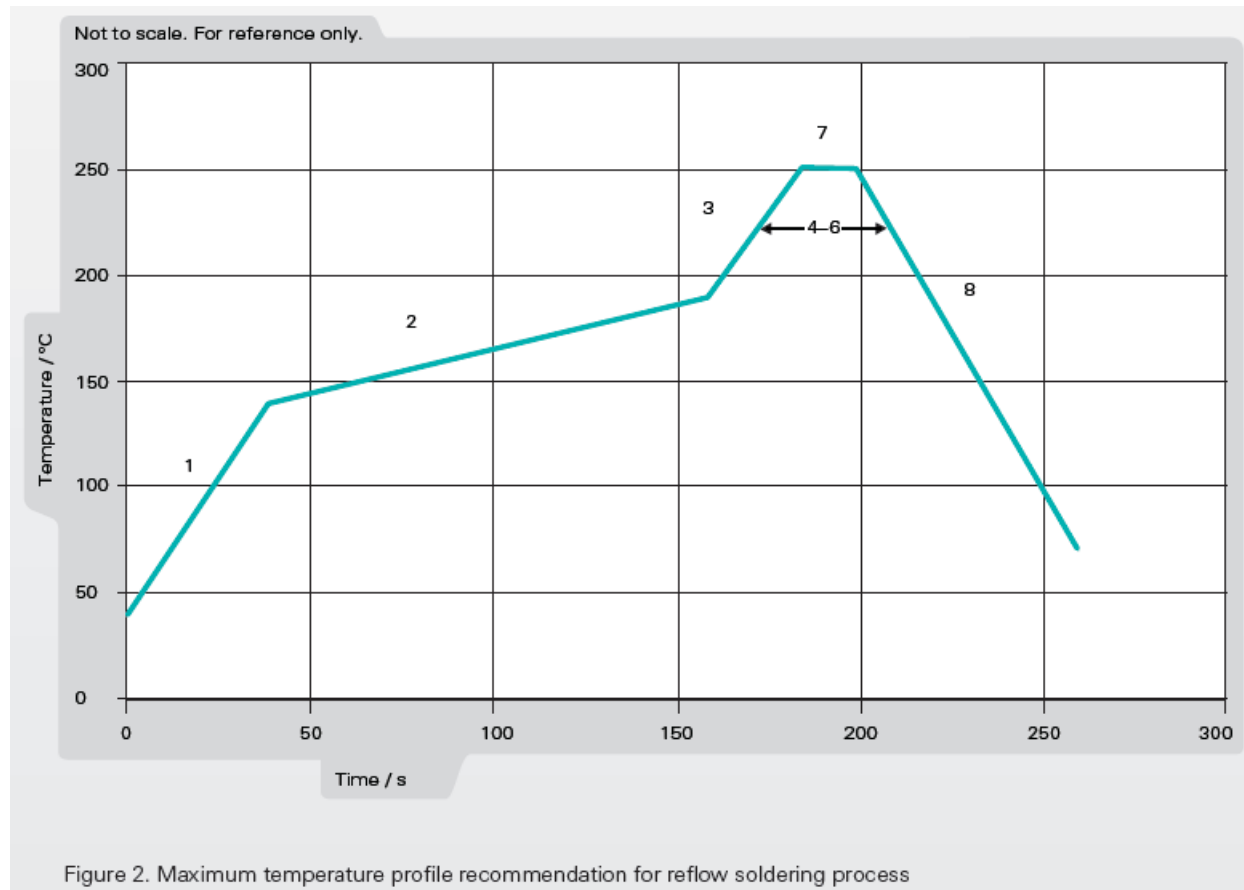

Issue: 2045

In the effort to improve our products, we reserve the right to make changes judged to be necessary.

CONFIDENTIAL AND PROPRIETARY INFORMATION

This document contains confidential and proprietary information of Pulse Electronics, Inc. (Pulse) and is protected by copyright, trade secret and other state and federal laws. Its receipt or possession does not convey any rights to reproduce, disclose its contents, or to manufacture, use or sell anything it may describe. Reproduction, disclosure or use without specific written authorization of Pulse is strictly forbidden.

Description: 824-2170MHz SMD Antenna

Series: Domino

PART NUMBER: W3544X

### TEST SETUP

#### Test Setup for Electrical Measurements

Recommended test board layout for electrical characteristic measurement. Test board outline size 110 mm x 50 mm. Ground cleared under antenna.

**NOTE:** All measurements are in mm.

**W3544A** - Antenna positioned vertically on PWB corner

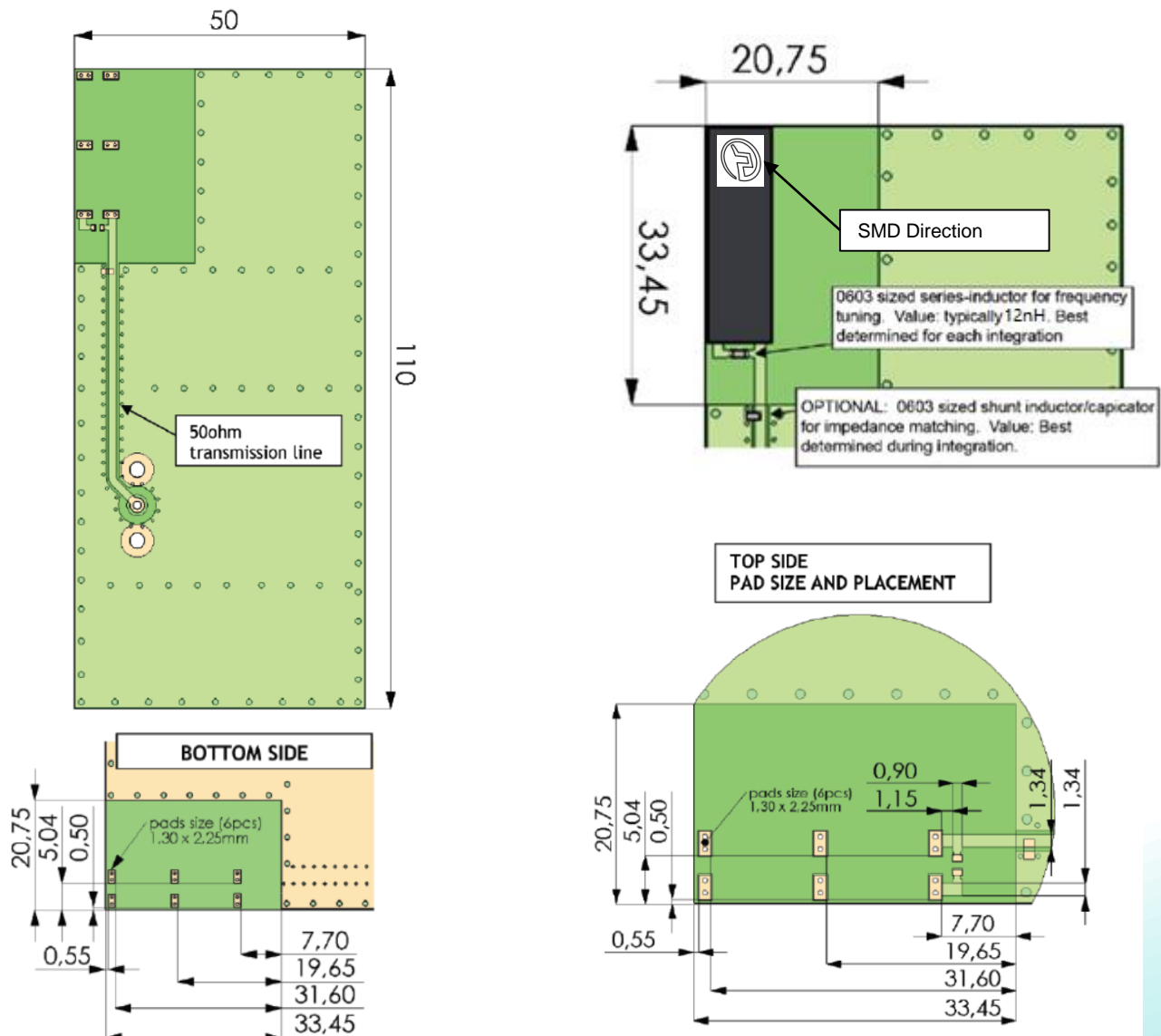

Issue: 2045

In the effort to improve our products, we reserve the right to make changes judged to be necessary.

CONFIDENTIAL AND PROPRIETARY INFORMATION

This document contains confidential and proprietary information of Pulse Electronics, Inc. (Pulse) and is protected by copyright, trade secret and other state and federal laws. Its receipt or possession does not convey any rights to reproduce, disclose its contents, or to manufacture, use or sell anything it may describe. Reproduction, disclosure or use without specific written authorization of Pulse is strictly forbidden.

Description: 824-2170MHz SMD Antenna

Series: Domino

PART NUMBER: W3544X

**W3544B** - Antenna positioned horizontally on PWB corner

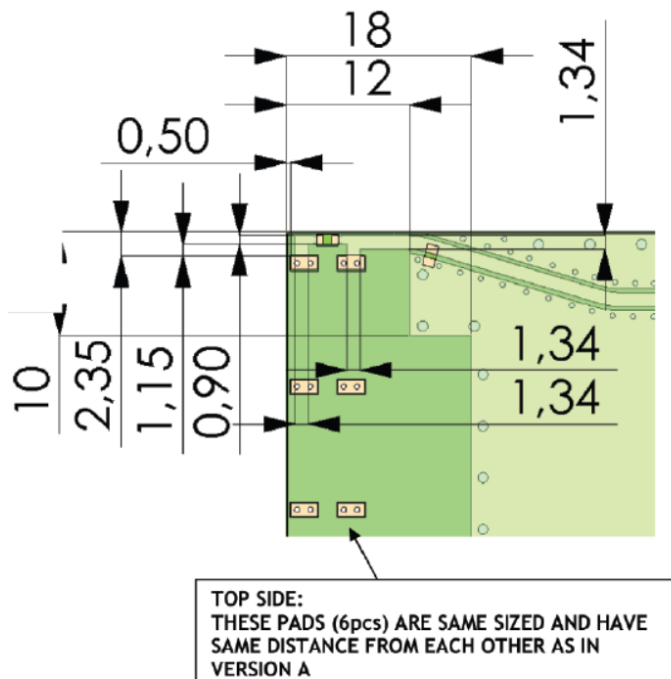
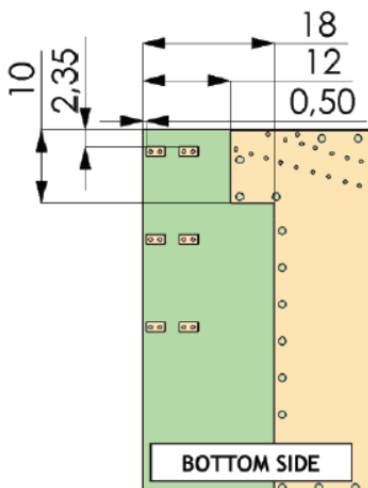
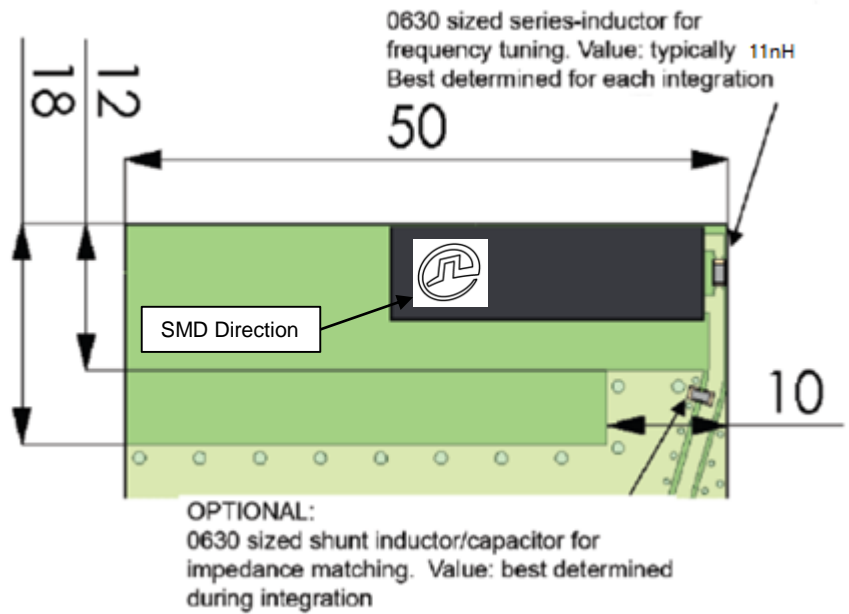
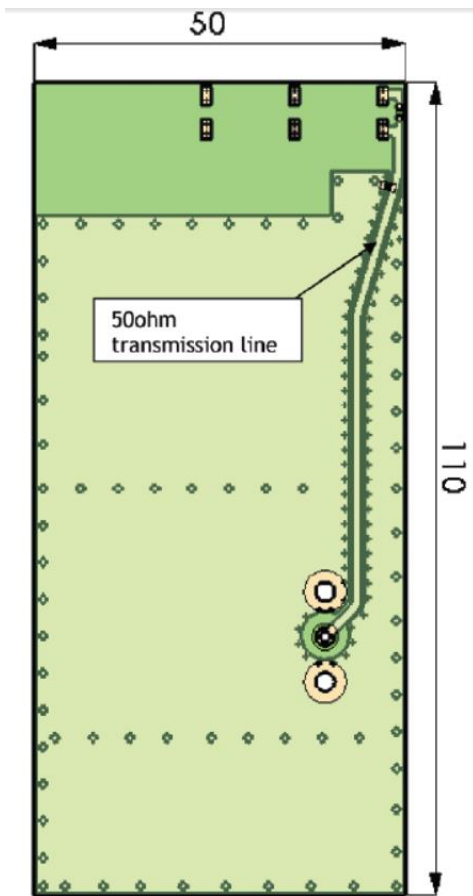

Issue: 2045

In the effort to improve our products, we reserve the right to make changes judged to be necessary.

CONFIDENTIAL AND PROPRIETARY INFORMATION

This document contains confidential and proprietary information of Pulse Electronics, Inc. (Pulse) and is protected by copyright, trade secret and other state and federal laws. Its receipt or possession does not convey any rights to reproduce, disclose its contents, or to manufacture, use or sell anything it may describe. Reproduction, disclosure or use without specific written authorization of Pulse is strictly forbidden.

Description: 824-2170MHz SMD Antenna

Series: Domino

PART NUMBER: W3544X

## CHARTS

### Return loss of W3544A

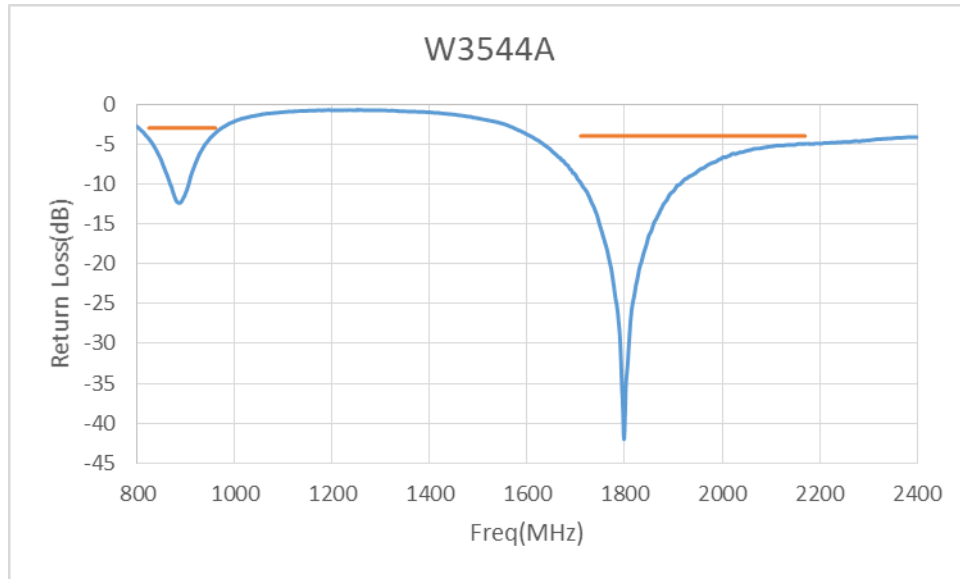

### Radiation Efficiency of W3544A

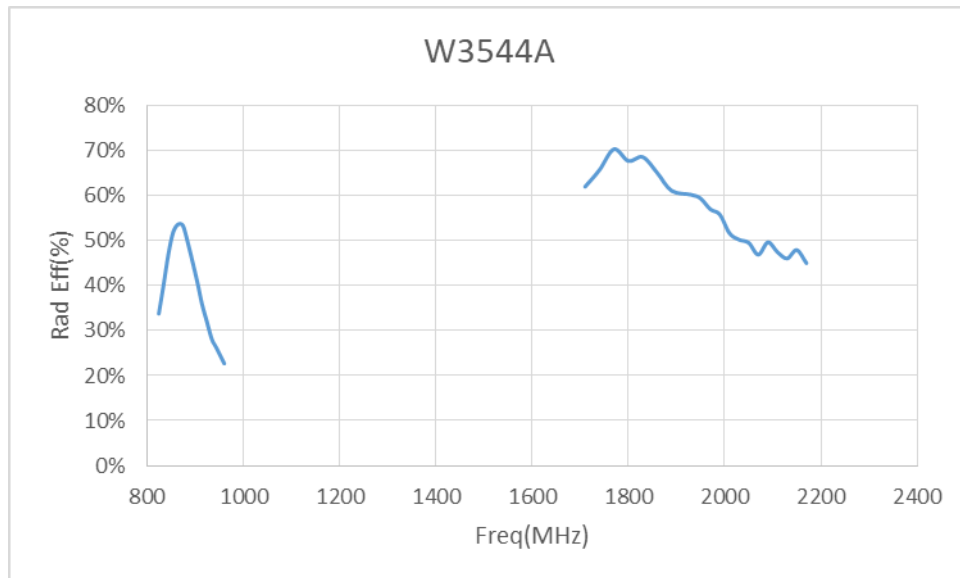

Issue: 2045

In the effort to improve our products, we reserve the right to make changes judged to be necessary.

CONFIDENTIAL AND PROPRIETARY INFORMATION

This document contains confidential and proprietary information of Pulse Electronics, Inc. (Pulse) and is protected by copyright, trade secret and other state and federal laws. Its receipt or possession does not convey any rights to reproduce, disclose its contents, or to manufacture, use or sell anything it may describe. Reproduction, disclosure or use without specific written authorization of Pulse is strictly forbidden.



Description: 824-2170MHz SMD Antenna

Series: Domino

PART NUMBER: W3544X

## CHARTS

### Peak Gain of W3544A

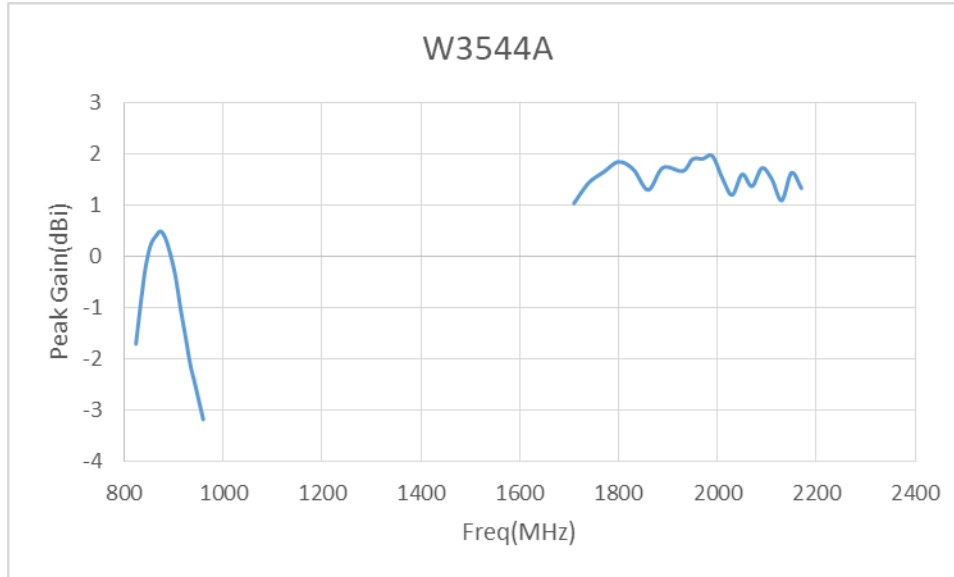

### Low band Radiation pattern at Vertical plane, front view of W3544A

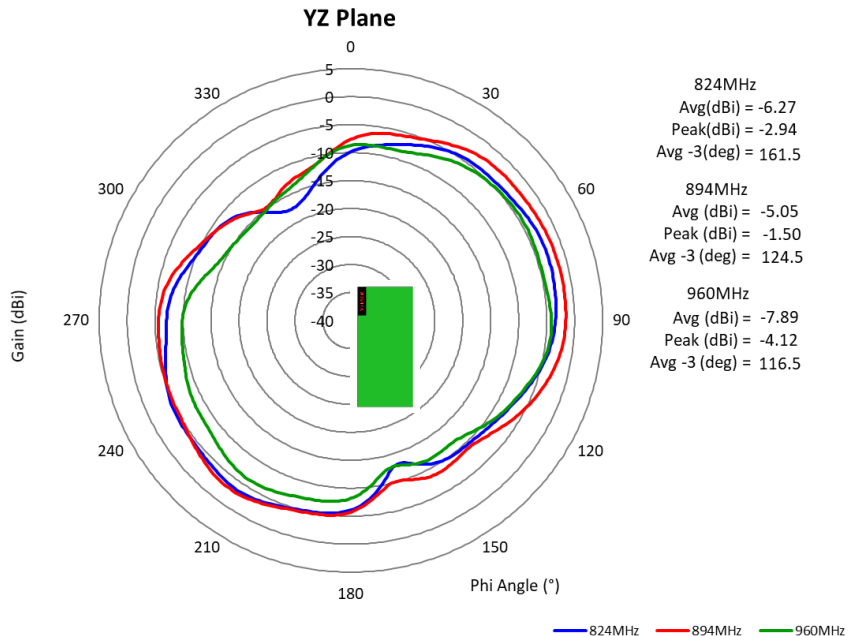

Issue: 2045

In the effort to improve our products, we reserve the right to make changes judged to be necessary.

CONFIDENTIAL AND PROPRIETARY INFORMATION

This document contains confidential and proprietary information of Pulse Electronics, Inc. (Pulse) and is protected by copyright, trade secret and other state and federal laws. Its receipt or possession does not convey any rights to reproduce, disclose its contents, or to manufacture, use or sell anything it may describe. Reproduction, disclosure or use without specific written authorization of Pulse is strictly forbidden.

Description: 824-2170MHz SMD Antenna

Series: Domino

PART NUMBER: W3544X

## CHARTS

### Low band Radiation pattern at Vertical plane, side view of W3544A

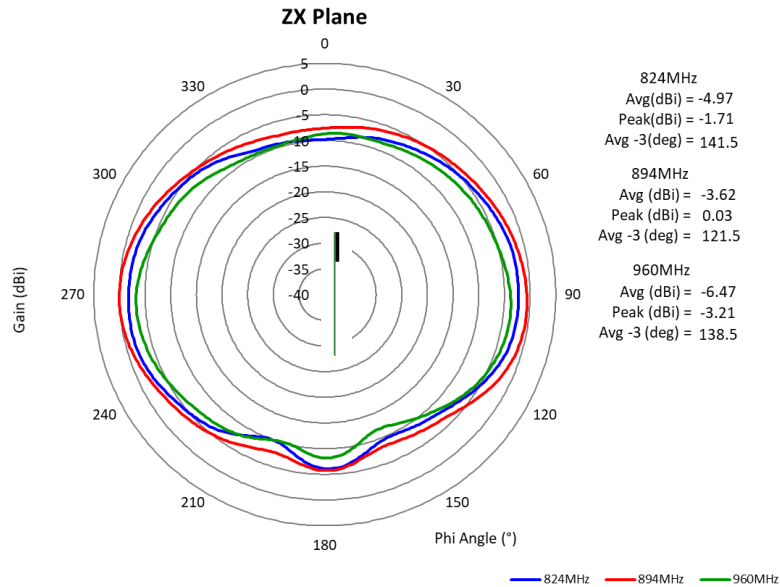

### Low band Radiation pattern at horizontal plane of W3544A

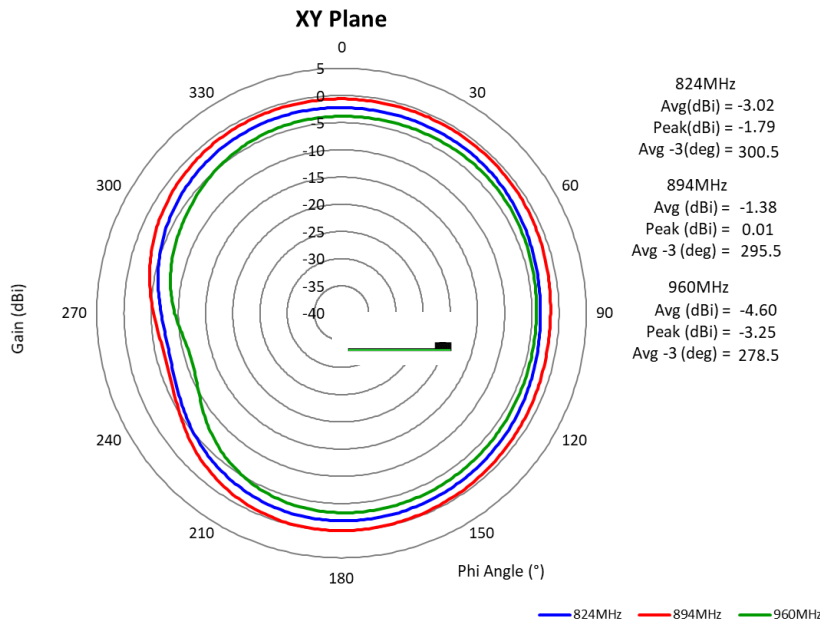

Issue: 2045

In the effort to improve our products, we reserve the right to make changes judged to be necessary.

CONFIDENTIAL AND PROPRIETARY INFORMATION

This document contains confidential and proprietary information of Pulse Electronics, Inc. (Pulse) and is protected by copyright, trade secret and other state and federal laws. Its receipt or possession does not convey any rights to reproduce, disclose its contents, or to manufacture, use or sell anything it may describe. Reproduction, disclosure or use without specific written authorization of Pulse is strictly forbidden.

Description: 824-2170MHz SMD Antenna

Series: Domino

PART NUMBER: W3544X

### CHARTS

High band Radiation pattern at Vertical plane, front view of W3544A

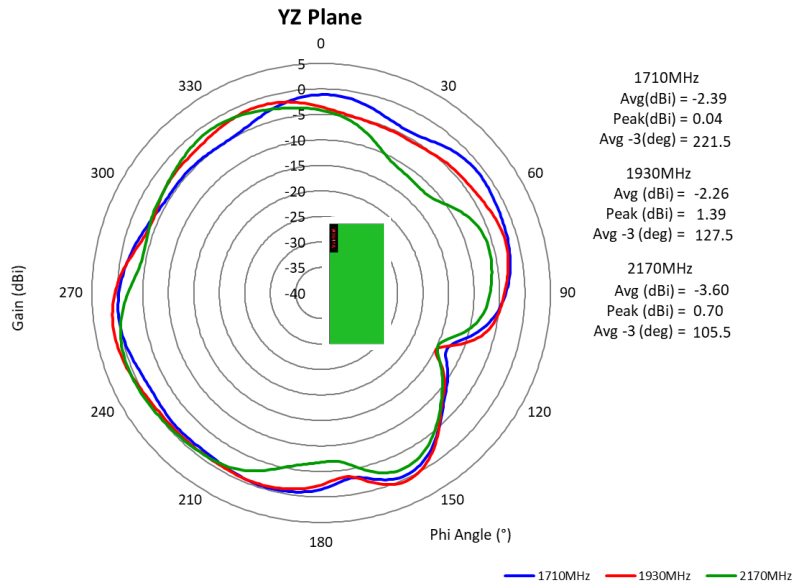

High band Radiation pattern at Vertical plane, side view of W3544A

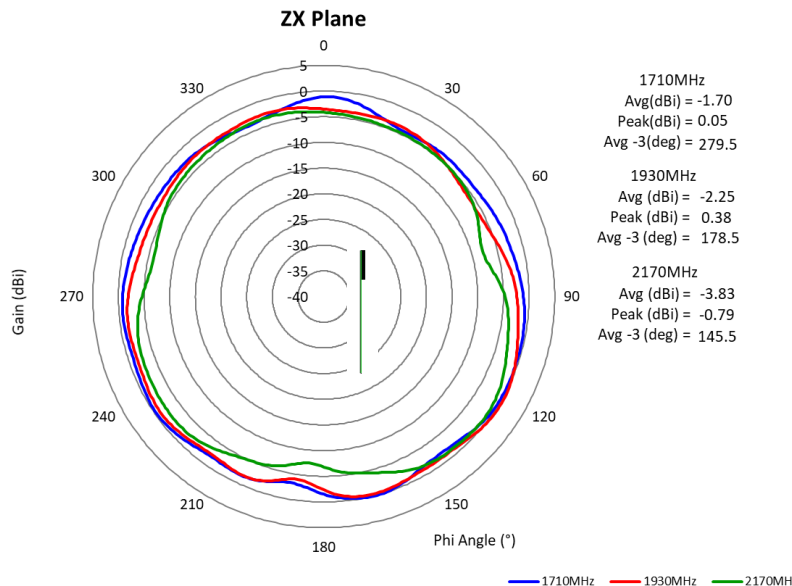

Issue: 2045

In the effort to improve our products, we reserve the right to make changes judged to be necessary.

CONFIDENTIAL AND PROPRIETARY INFORMATION

This document contains confidential and proprietary information of Pulse Electronics, Inc. (Pulse) and is protected by copyright, trade secret and other state and federal laws. Its receipt or possession does not convey any rights to reproduce, disclose its contents, or to manufacture, use or sell anything it may describe. Reproduction, disclosure or use without specific written authorization of Pulse is strictly forbidden.

Description: 824-2170MHz SMD Antenna

Series: Domino

PART NUMBER: W3544X

## CHARTS

### High band Radiation pattern at Horizontal plane of W3544A

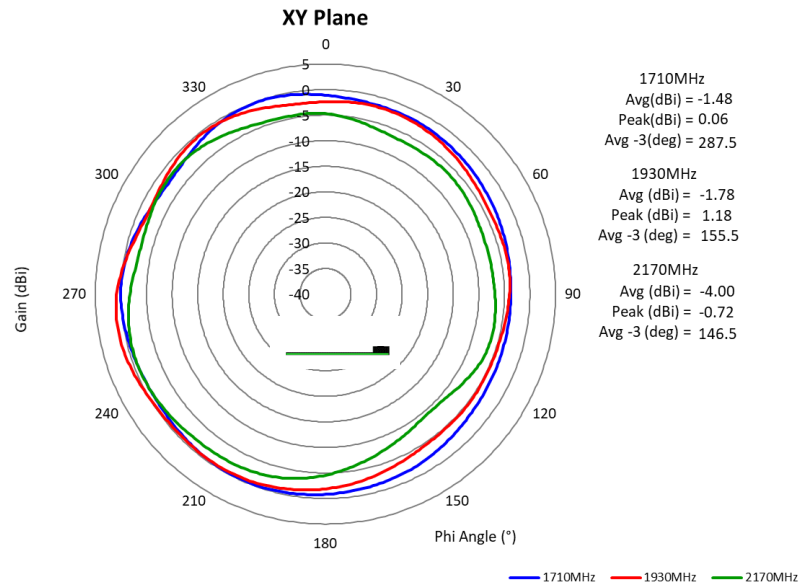

Issue: 2045

In the effort to improve our products, we reserve the right to make changes judged to be necessary.

CONFIDENTIAL AND PROPRIETARY INFORMATION

This document contains confidential and proprietary information of Pulse Electronics, Inc. (Pulse) and is protected by copyright, trade secret and other state and federal laws. Its receipt or possession does not convey any rights to reproduce, disclose its contents, or to manufacture, use or sell anything it may describe. Reproduction, disclosure or use without specific written authorization of Pulse is strictly forbidden.

Description: 824-2170MHz SMD Antenna

Series: Domino

PART NUMBER: W3544X

### CHARTS

#### Return loss of W3544B

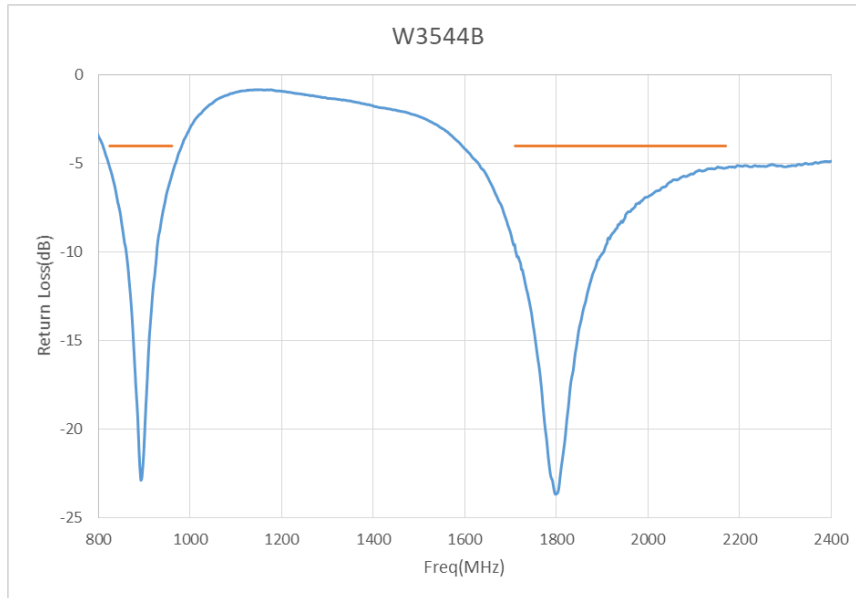

#### Radiation Efficiency of W3544B

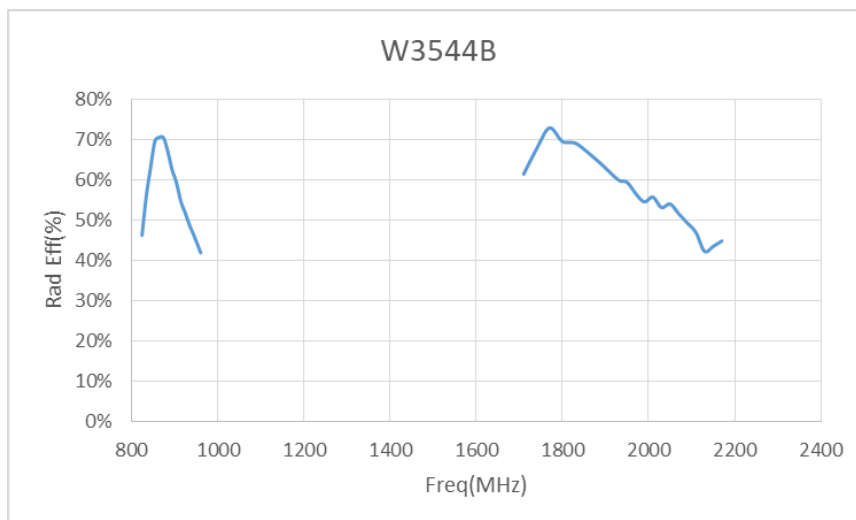

Issue: 2045

In the effort to improve our products, we reserve the right to make changes judged to be necessary.

CONFIDENTIAL AND PROPRIETARY INFORMATION

This document contains confidential and proprietary information of Pulse Electronics, Inc. (Pulse) and is protected by copyright, trade secret and other state and federal laws. Its receipt or possession does not convey any rights to reproduce, disclose its contents, or to manufacture, use or sell anything it may describe. Reproduction, disclosure or use without specific written authorization of Pulse is strictly forbidden.

Description: 824-2170MHz SMD Antenna

Series: Domino

PART NUMBER: W3544X

## CHARTS

### Peak Gain of W3544B

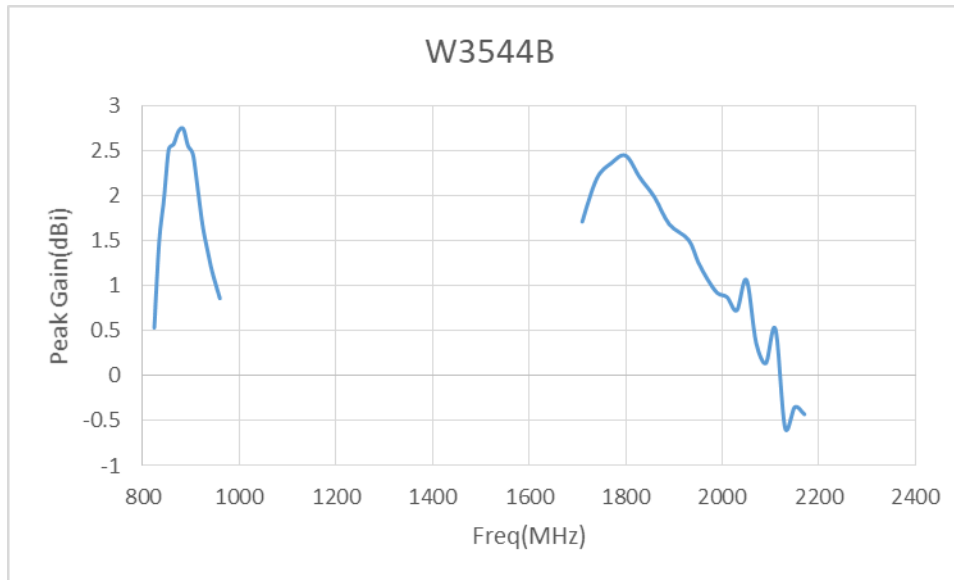

### Low band Radiation pattern at Vertical plane, front view of W3544B

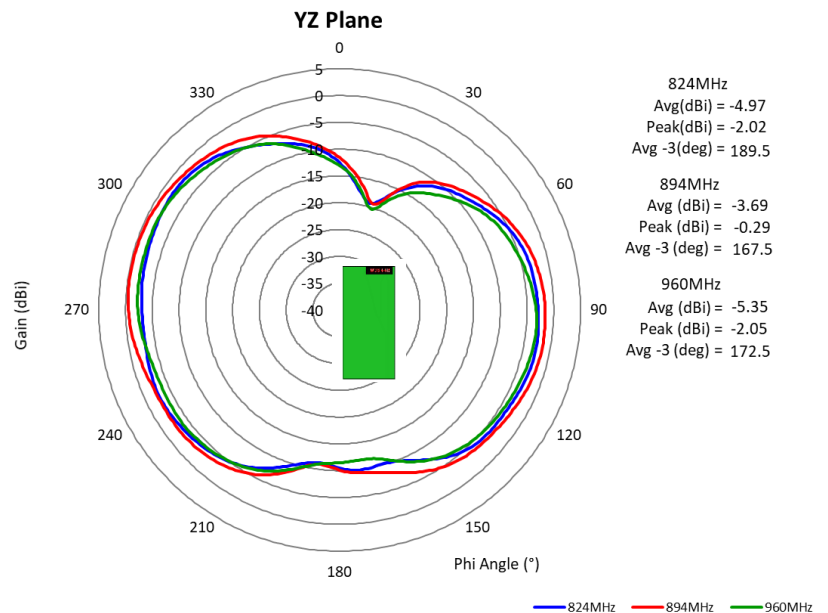

Issue: 2045

In the effort to improve our products, we reserve the right to make changes judged to be necessary.

CONFIDENTIAL AND PROPRIETARY INFORMATION

This document contains confidential and proprietary information of Pulse Electronics, Inc. (Pulse) and is protected by copyright, trade secret and other state and federal laws. Its receipt or possession does not convey any rights to reproduce, disclose its contents, or to manufacture, use or sell anything it may describe. Reproduction, disclosure or use without specific written authorization of Pulse is strictly forbidden.

Description: 824-2170MHz SMD Antenna

Series: Domino

PART NUMBER: W3544X

## CHARTS

### Low band Radiation pattern at Vertical plane, side view of W3544B

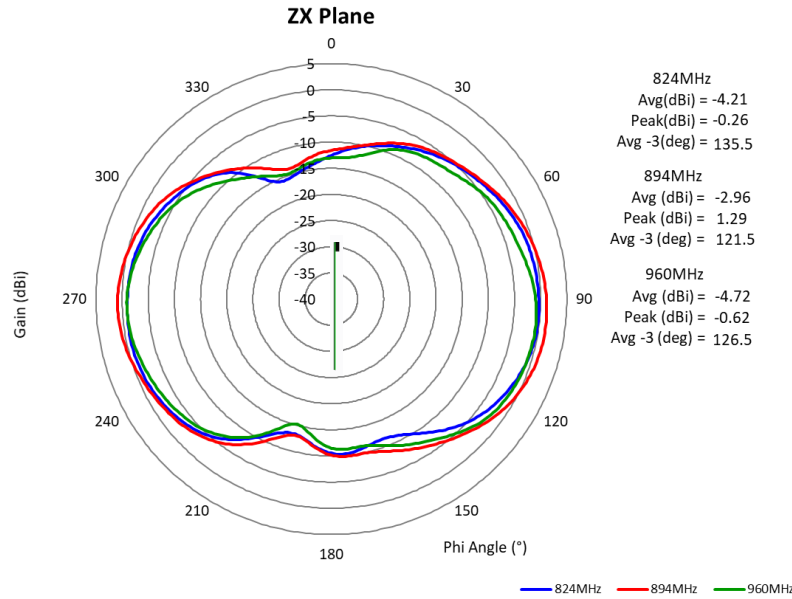

### Low band Radiation pattern at horizontal plane of W3544B

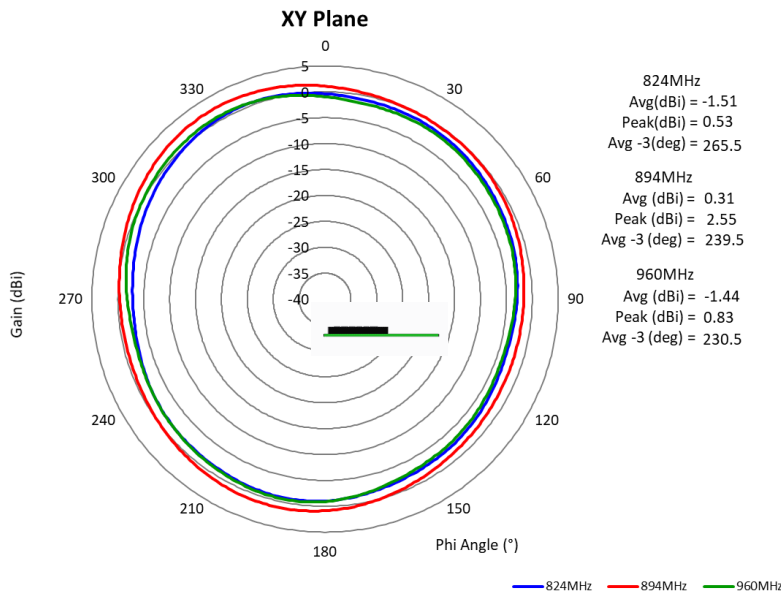

Issue: 2045

In the effort to improve our products, we reserve the right to make changes judged to be necessary.

CONFIDENTIAL AND PROPRIETARY INFORMATION

This document contains confidential and proprietary information of Pulse Electronics, Inc. (Pulse) and is protected by copyright, trade secret and other state and federal laws. Its receipt or possession does not convey any rights to reproduce, disclose its contents, or to manufacture, use or sell anything it may describe. Reproduction, disclosure or use without specific written authorization of Pulse is strictly forbidden.

Description: 824-2170MHz SMD Antenna

Series: Domino

PART NUMBER: W3544X

### CHARTS

High band Radiation pattern at Vertical plane, front view of W3544B

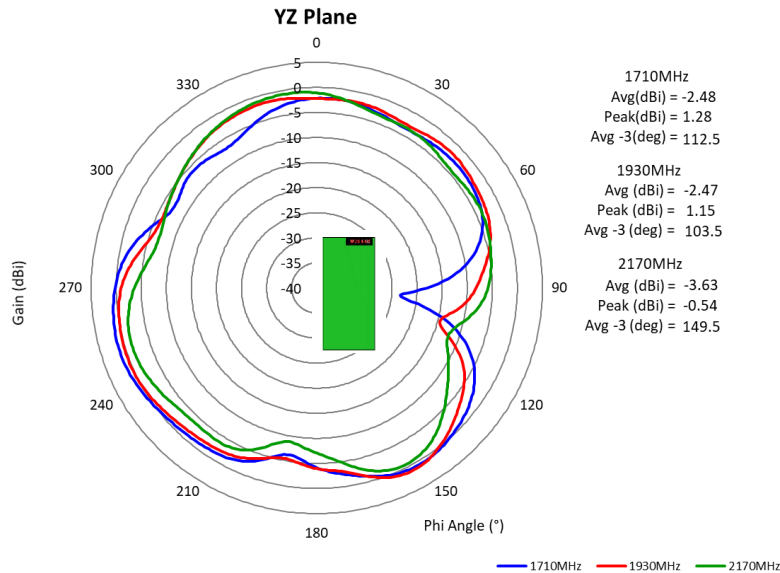

High band Radiation pattern at Vertical plane, side view of W3544B

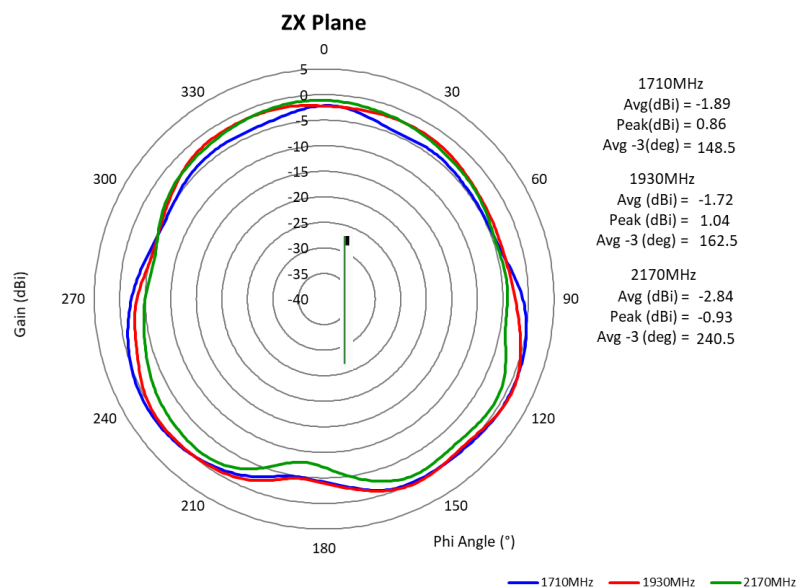

Issue: 2045

In the effort to improve our products, we reserve the right to make changes judged to be necessary.

CONFIDENTIAL AND PROPRIETARY INFORMATION

This document contains confidential and proprietary information of Pulse Electronics, Inc. (Pulse) and is protected by copyright, trade secret and other state and federal laws. Its receipt or possession does not convey any rights to reproduce, disclose its contents, or to manufacture, use or sell anything it may describe. Reproduction, disclosure or use without specific written authorization of Pulse is strictly forbidden.



Description: 824-2170MHz SMD Antenna

Series: Domino

PART NUMBER: W3544X

CHARTS

High band Radiation pattern at Horizontal plane of W3544B

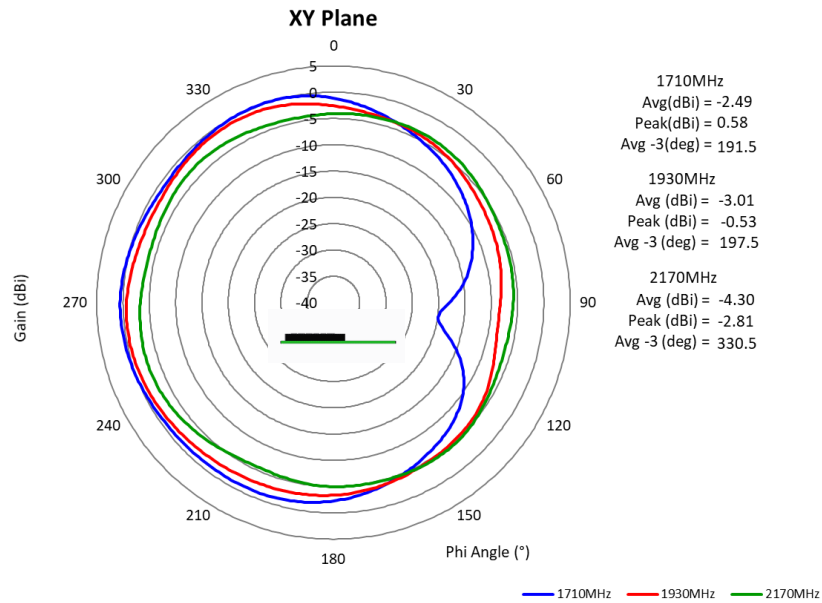

Issue: 2045

In the effort to improve our products, we reserve the right to make changes judged to be necessary.

CONFIDENTIAL AND PROPRIETARY INFORMATION

This document contains confidential and proprietary information of Pulse Electronics, Inc. (Pulse) and is protected by copyright, trade secret and other state and federal laws. Its receipt or possession does not convey any rights to reproduce, disclose its contents, or to manufacture, use or sell anything it may describe. Reproduction, disclosure or use without specific written authorization of Pulse is strictly forbidden.

Description: 824-2170MHz SMD Antenna

Series: Domino

PART NUMBER: W3544X

## PACKAGING

140pcs Antennas Per 1pcs 7" Tape & Reel

10 pcs 7" Tape & Reel (total 1,400 pcs Antennas) per 1 box

ITEM	W	A0	B0	K0	P	F	E	D	D1	P0	P2	t	7"	
DIM	16.0	26.7	8.35	3.3	32.0	7.5	1.75	1.50	1.50	4.00	2.00	0.3	LENGTH / REEL	UNITS / REEL
TOLE	+0.30 -0.30	+0.10 -0.10	+0.10 -0.10	+0.10 -0.10	+0.10 -0.10	+0.10 -0.10	+0.10 -0.10	+0.10 -0.00	+0.10 -0.00	+0.10 -0.10	+0.10 -0.10	+0.05 -0.05	4.7M/R	140PCS

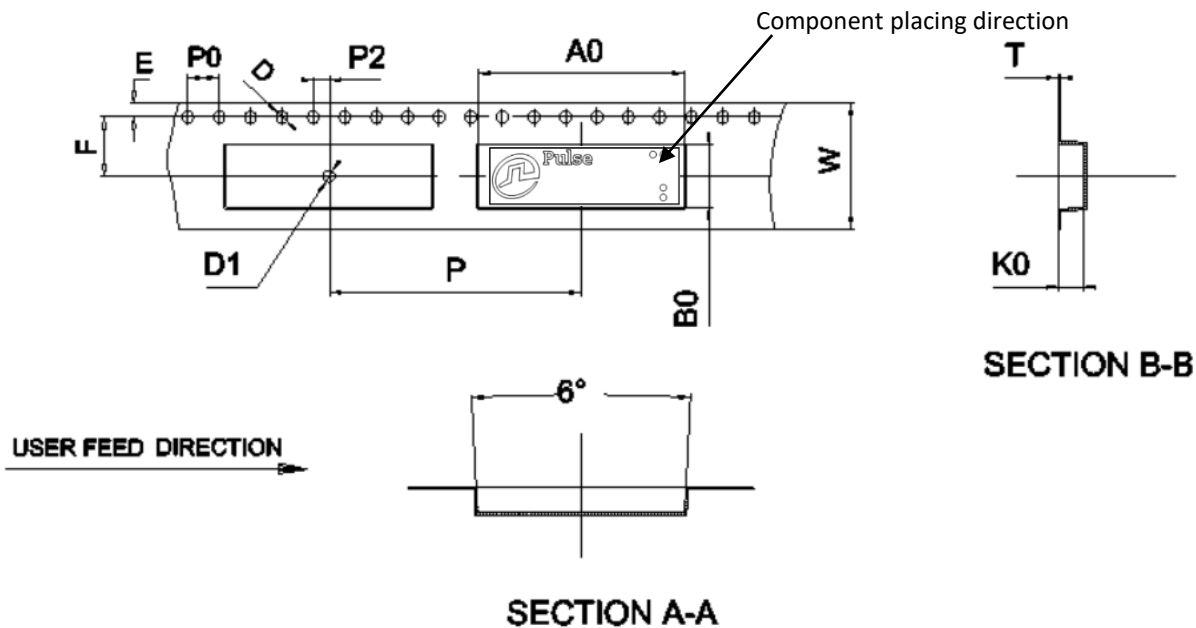

According to MSL3 packing requirement, MBB-Moisture Barrel Bag, Desiccant, HIC-Humidity Indicator Card, MSID Label, Caution Label are required.



Issue: 2045

In the effort to improve our products, we reserve the right to make changes judged to be necessary.  
CONFIDENTIAL AND PROPRIETARY INFORMATION

This document contains confidential and proprietary information of Pulse Electronics, Inc. (Pulse) and is protected by copyright, trade secret and other state and federal laws. Its receipt or possession does not convey any rights to reproduce, disclose its contents, or to manufacture, use or sell anything it may describe. Reproduction, disclosure or use without specific written authorization of Pulse is strictly forbidden.

**Description:** 824-2170MHz SMD Antenna**Series:** Domino**PART NUMBER:** W3544X**ASSEMBLY**

Part Number	Positioning
W3544A	Vertically mounted at board edge
W3544B	Horizontally mounted at board edge

# Mouser Electronics

Authorized Distributor

Click to View Pricing, Inventory, Delivery & Lifecycle Information:

Pulse:

[W3544A](#) [W3544B](#)